

CONGRATULATIONS

on the purchase of your new professional switch mode battery charger. This charger is included in a series of professional chargers from CTEK SWEDEN AB and represents the latest technology in battery charging. MXTS 40 is a charger with multiple adjustable parameters.

SAFETY

- THE CHARGER IS DESIGNED FOR CHARGING ONLY BATTERIES ACCORDING TO THE TECHNICAL SPECIFICATION. DO NOT USE THE CHARGER FOR ANY OTHER PURPOSE. ALWAYS FOLLOW BATTERY MANUFACTURERS RECOMMENDATIONS.
- NEVER TRY TO CHARGE NON RECHARGEABLE BATTERIES.
- CHECK THE CABLES PRIOR TO USE. ENSURE THAT NO CRACKS HAVE OCCURRED IN THE CABLES OR BEND PROTECTION. A CHARGER WITH DAMAGED CABLES MUST NOT BE USED. A DAMAGED CABLE MUST BE REPLACED BY AN ORIGINAL PART SUPPLIED BY CTEK.
- NEVER CHARGE A DAMAGED BATTERY.
- NEVER CHARGE A FROZEN BATTERY.
- NEVER PLACE THE CHARGER ON TOP OF THE BATTERY WHEN CHARGING.
- ALWAYS PROVIDE FOR PROPER VENTILATION DURING CHARGING.
- AVOID COVERING THE CHARGER.
- A BATTERY BEING CHARGED COULD EMIT EXPLOSIVE GASES. PREVENT SPARKS CLOSE TO THE BATTERY.
- ALL BATTERIES FAIL SOONER OR LATER. A BATTERY THAT FAILS DURING CHARGING IS NORMALLY TAKEN CARE OF BY THE CHARG-

ERS ADVANCED CONTROL, BUT SOME RARE ERRORS IN THE BATTERY COULD STILL EXIST. DON'T LEAVE ANY BATTERY DURING CHARGING UNATTENDED FOR A LONGER PERIOD OF TIME.

- ENSURE THAT THE CABLING DOES NOT JAM OR COMES INTO CONTACT WITH HOT SURFACES OR SHARP EDGES.
- BATTERY ACID IS CORROSIVE. RINSE IMMEDIATELY WITH WATER IF ACID COMES INTO CONTACT WITH SKIN OR EYES, SEEK IMMEDIATE MEDICAL ADVICE.
- ALWAYS CHECK THAT THE CHARGER HAS SWITCHED TO STEP 7 BEFORE LEAVING THE CHARGER UNATTENDED AND CONNECTED FOR LONG PERIODS. IF THE CHARGER HAS NOT SWITCHED TO STEP 7 WITHIN 55 HOURS, THIS IS AN INDICATION OF AN ERROR. MANUALLY DISCONNECT THE CHARGER.
- BATTERIES CONSUME WATER DURING USE AND CHARGING. FOR BATTERIES WHERE WATER CAN BE ADDED, THE WATER LEVEL SHOULD BE CHECKED REGULARLY. IF THE WATER LEVEL IS LOW ADD DISTILLED WATER.
- **(IEC 7.12 ED.5)** THIS APPLIANCE IS NOT INTENDED FOR USE BY PERSONS (INCLUDING CHILDREN) WITH REDUCED PHYSICAL, SENSORY OR MENTAL CAPABILITIES, OR LACK OF EXPERIENCE AND KNOWLEDGE, UNLESS THEY HAVE BEEN GIVEN SUPERVISION OR INSTRUCTION CONCERNING USE OF THE APPLIANCE BY A PERSON

- RESPONSIBLE FOR THEIR SAFETY. CHILDREN SHOULD BE SUPERVISED TO ENSURE THAT THEY DO NOT PLAY WITH THE APPLIANCE. **(EN 7.12)** THIS APPLIANCE CAN BE USED BY CHILDREN AGED FROM 8 YEARS AND ABOVE AND PERSONS WITH REDUCED PHYSICAL, SENSORY OR MENTAL CAPABILITIES, OR LACK OF EXPERIENCE AND KNOWLEDGE IF THEY HAVE BEEN GIVEN SUPERVISION OR INSTRUCTION CONCERNING USE OF THE APPLIANCE IN A SAFE WAY AND UNDERSTAND THE HAZARDS INVOLVED. CHILDREN SHALL NOT PLAY WITH THE APPLIANCE. CLEANING AND USER MAINTENANCE SHALL NOT BE MADE BY CHILDREN WITHOUT SUPERVISION.
- CONNECTION TO THE MAINS SUPPLY MUST BE IN ACCORDANCE WITH THE NATIONAL REGULATIONS FOR ELECTRICAL INSTALLATIONS.
- CHARGERS WITH GROUNDED MAINS PLUG MUST ONLY BE CONNECTED TO A GROUNDED SOCKET OUTLET.
- DON'T PLACE A FAN-COOLED CHARGER SO THAT DUST, DIRT OR SIMILAR CAN BE SUCKED INTO THE FAN.
- CHARGERS WITH IP-CLASS LOWER THAN IPX4 ARE DESIGNED FOR INDOOR USE. SEE TECHNICAL SPECIFICATION. DO NOT EXPOSE TO RAIN OR SNOW.

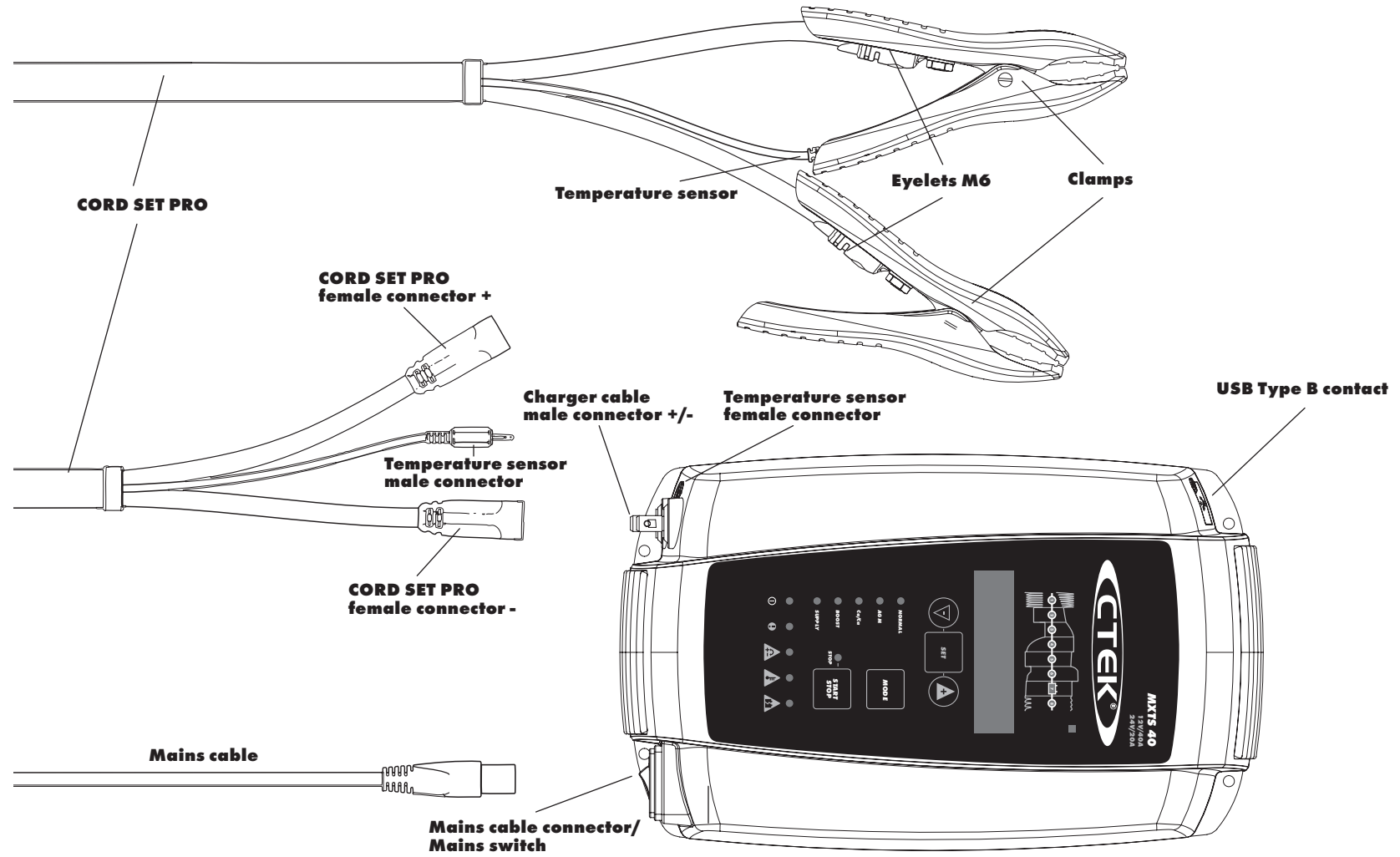

QUICK GUIDE

To charge, **with last used program settings**

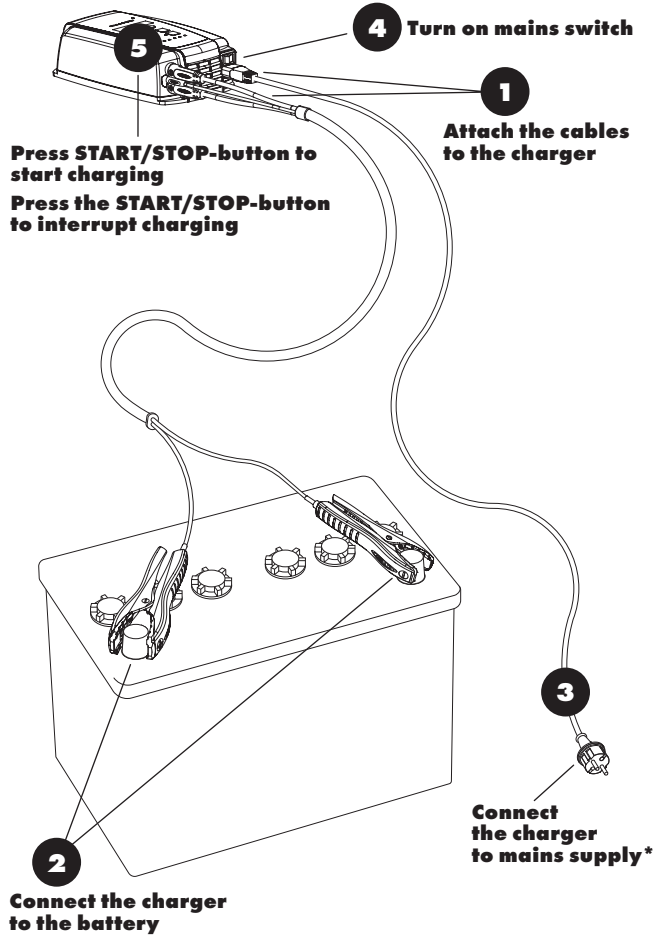

*Supply plugs may differ to suit your mains supply.



WARNING!

Batteries and electronics will be damaged if 12V batteries are charged in 24V-setting.



MOUNTING

When permanently mounting the charger, mount the charger on a firm surface. Fix the charger with screws in the four holes. Use suitable screws or fixings. Allow space around the charger to not interfere with air cooling.

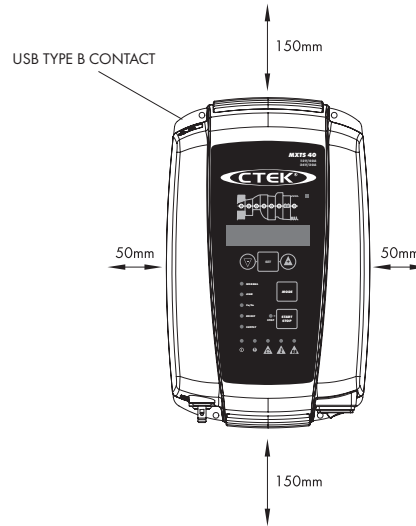

USB TYPE B CONTACT

For service only.

NOTE: Not to be used to charge mobile phones etc.

READY TO USE

Table shows estimated time to take battery from empty to 80% charged.

		BATTERY SIZE					
		10Ah	20Ah	50Ah	100Ah	600Ah	1200Ah
CHARGING CURRENT	5A	2h	3h	8h			
	10A		2h	4h	8h		
	20A			2h	4h	24h	
	30A				3h	16h	
	40A				2h	12h	24h

CONNECT THE CABLES

If the battery clamps are incorrectly connected, the reverse polarity protection will ensure that the battery and charger are not damaged.

- Connect the battery cables **1**, including the temperature sensor, to the charger.
- Connect the mains cable **2** to the charger.
- Connect the red clamp **3** to the battery's positive pole.
- Connect the black clamp **4** to the vehicle chassis remote from the fuel pipe and the battery.
- Connect the charger **5** to the mains supply.
- Turn on mains switch **6**.

DISCONNECT THE CABLES

- Turn off mains switch **6**.
- Disconnect the charger from the mains supply **5** before disconnecting the battery.
- Disconnect the black clamp **4** before the red clamp **3**.

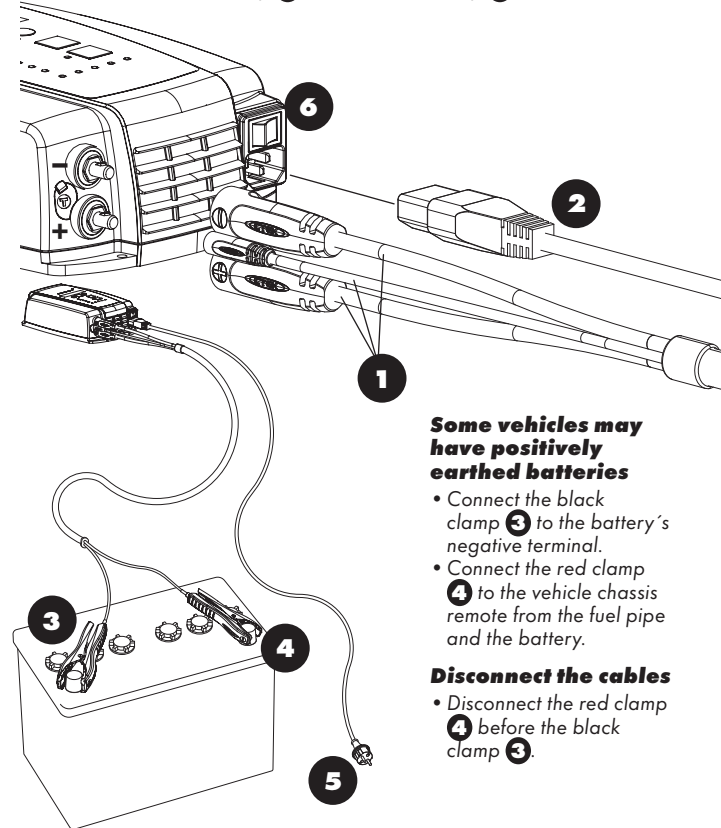

Some vehicles may have positively earthed batteries

- Connect the black clamp **3** to the battery's negative terminal.
- Connect the red clamp **4** to the vehicle chassis remote from the fuel pipe and the battery.

Disconnect the cables

- Disconnect the red clamp **4** before the black clamp **3**.

CHARGING

For best possible charging of your batteries the voltage and current is adjustable. In addition temperature compensated charging is selectable. See below how to set the parameters for customized charging.

1. Connect the charger cables to the charger

(see quickguide).

2. Connect the charger to the battery

(see quickguide).

3. Connect the charger to the mains supply

4. Turn on the mains switch

The power lamp will indicate that the mains cable is connected to the mains supply. The error lamp will indicate if the battery clamps are incorrectly connected. The reverse polarity protection will ensure that the battery or charger will not be damaged.

5. Press the MODE-button to select charging program

6. Press SET-button to set parameters

7. Select voltage

- Display (h) will indicate that voltage (V) is selectable.
- Display (V) will flash and indicate set voltage.
- Press +/- to change.
- Press SET-button to confirm.

8. Select current

- Display (Ah & info) will indicate that current (A) is selectable.
- Display (A) will flash and indicate set current.
- Press +/- to change.
- Press SET-button to confirm.

9. Select temperature compensation

- Display (h) will indicate that temperature compensation (T) is selectable.
- Display (Ah & info) will indicate ON/OFF.
- Press +/- to change.
- Press SET-button to confirm.

10. Press the START/STOP-button to start charging cycle or press MODE-button to change charging program

11. Follow the 8-step display through the charging process

The battery is ready to start the engine when STEP 4 is lit. The battery is fully charged when STEP 7 is lit.

12. Stop charging at any time by pressing the START/STOP-button

13. Press START/STOP-button to start charging cycle

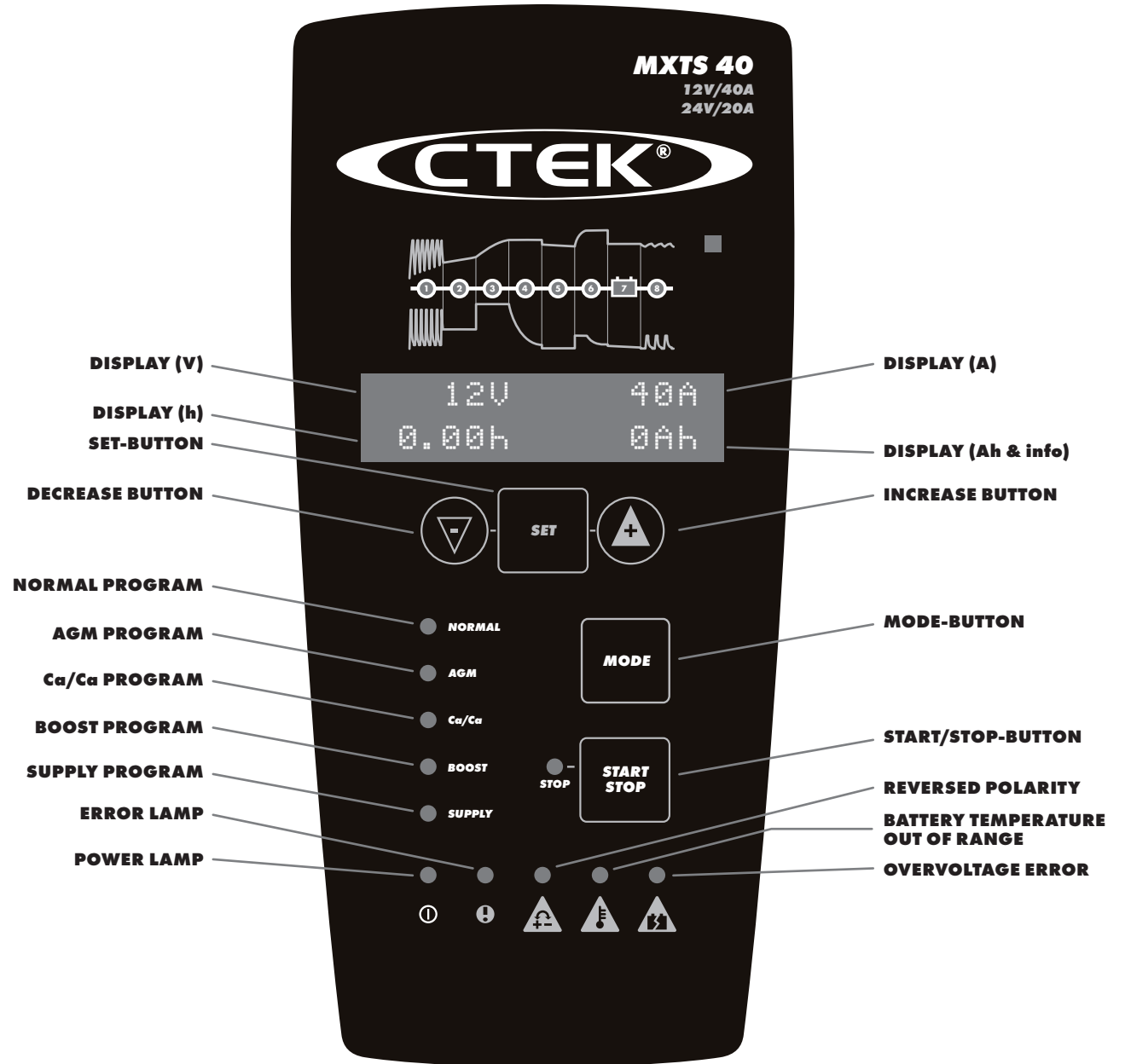

SUPPLY

For best possible float maintenance charging or voltage supply function for the vehicle the voltage and max current limit are adjustable from the front panel. See below how to set the voltage supply program and it's parameters.

1. Connect the charger cables to the charger

(see "Cable connection").

2. Connect the charger to the battery

(see "Cable connection").

3. Connect the charger to the mains supply

4. Turn on the mains switch

The power lamp will indicate that the mains cable is connected to the mains supply. The error lamp will indicate if the battery clamps are incorrectly connected. The reverse polarity protection will ensure that the battery or charger will not be damaged.

5. Press the MODE-button to select Supply mode

6. Press SET-button to set parameters

7. Select voltage

- Display (h) will indicate that voltage (V) is selected.
- Display (V) will indicate set voltage.
- Press +/- to change.
- Press SET-button to confirm.

8. Select Supply voltage

- Display (h) will indicate that Supply voltage (V) is selected.
- Display (V) will flash and indicate Supply voltage level.
- Press +/- to change.
- Press SET-button to confirm.

9. Select current

- Display (Ah & info) will indicate that current (A) is selected.
- Display (A) will flash and indicate set current.
- Press +/- to change.
- Press SET-button to confirm.

10. Press the START/STOP-button to start Supply mode

11. Supply mode indication

STEP 7 is lit to indicate that Supply mode is running.

12. Stop Supply at any time by pressing the START/STOP-button



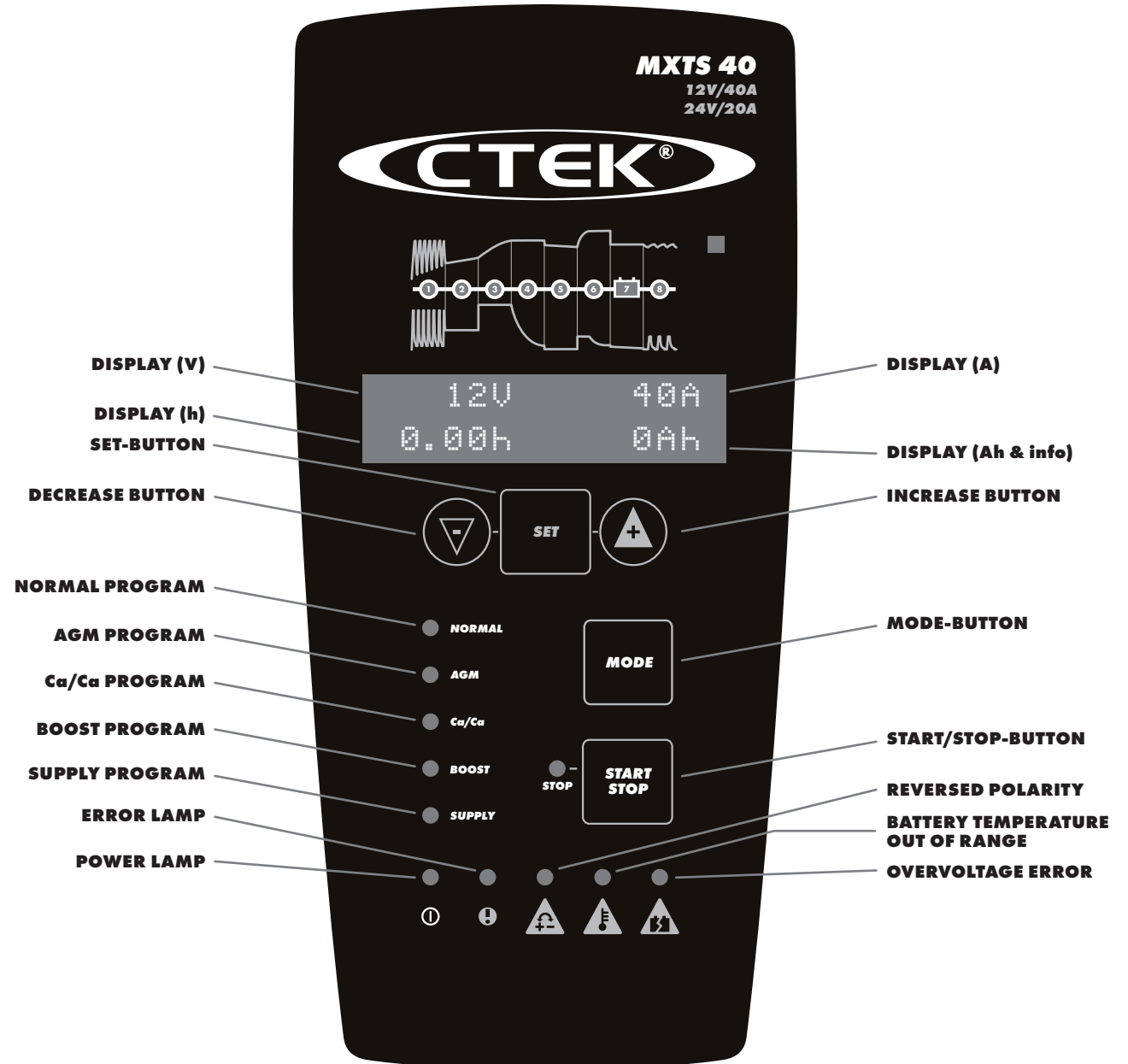

13. Press START/STOP-button to start Supply mode

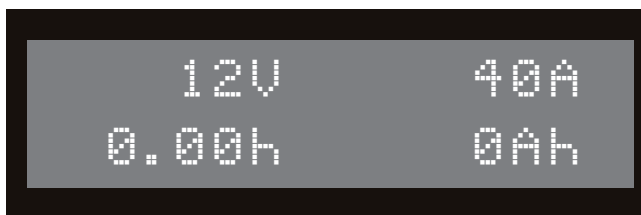

INDICATION LAMPS, DISPLAYS AND ERROR CODES



INDICATION LAMPS:

-  **POWER LAMP**
Power connected and switched on.
-  **GENERAL ERROR LAMP**
An error has been detected.
-  **POLARITY ERROR**
Reversed polarity or short circuit in charge cables error.
-  **BATTERY ERROR**
Battery temperature error. The battery is too hot to charge.
-  **BATTERY VOLTAGE ERROR**
Overvoltage error on battery connection.

SETTINGS BEFORE START:

DISPLAY (V)

Indicates voltage set
Options: 12/24 Volts

Supply voltage

Indicates voltage set
Options: 13, 6/14, 0/14, 4/14, 8V in 12V setting
Options: 27, 2/28, 0/28, 8/29, 6V in 24V setting

DISPLAY (A)

Indicates current set
Options: 40/30/20/10A in 12V setting
Options: 20/15/10/5A in 24V setting

DISPLAY (h)

Indicates which parameter to set
Options: V/SV/A/T/RT[h]
V = Nominal Voltage
SV = Supply Voltage
T = Temperature compensation
RT[h] = Recond time in BOOST program

DISPLAY (h) + (Ah & info)

Displays error codes
A = Current limit

REAL TIME INDICATION DURING CHARGING:

DISPLAY (V)

Displays output voltage

DISPLAY (A)

Displays output current

DISPLAY (h)

Alt. 1. Displays total elapsed charging time (minutes/hours)
Alt. 2. Displays time elapsed until error occurred
Alt. 3. Displays error message

DISPLAY (Ah & info)

Alt.1. Displays total charge delivered since start (minutes/hours)
Alt.2. Displays error codes together with ERROR lamp



ERROR CODES:

- E01 REVERSE POLARITY**
Connect the charger according to “quickguide”.
- E02 OVER VOLTAGE**
Battery voltage too high for the chosen charging program, check battery voltage.
- E03 TIME OUT STEP 1: DESULPHATION**
Restart the charger. If charging is still being interrupted the battery is seriously sulphated and may need to be replaced.
- E04 TIME OUT STEP 2: SOFT START**
Restart the charger. If charging is still being interrupted the battery can not accept charge and may need to be replaced.
- E05 STEP 5: ANALYSE**
Restart the charger. If charging is still being interrupted the battery cannot retain charge and may need to be replaced.
- E06 BATTERY OVERHEATED**
The battery is too hot to charge. The battery is damaged and may need to be replaced.
- E07 LOW BATTERY VOLTAGE IN SUPPLY PROGRAM**
Battery voltage too low or too large consumers connected. Check if 12V battery connected in 24V battery setting or disconnect large consumers.
- E08 HIGH CURRENT IN SUPPLY PROGRAM**
Check if clamps are short circuited or connected reversed polarity.

- E09 CHARGE MODE ERROR/START-UP FAIL**
 - 1.** If the unit is in a charge mode: there are too many loads placed on the battery.
Action: Remove any possible parallel loads, reset the error and re-start the charge cycle.
 - 2.** If the unit is in a charge mode: the battery is deeply discharged.
Action: Select supply mode for a short while and then re-start the charge cycle.
 - 3.** Start-up has failed. This is due to an internal error. Buttons will be disabled and you will be unable to re-start the unit.
Action: Please follow the warranty procedures outlined in this user guide.
- E99 OVER VOLTAGE PROTECTION**
If battery voltage is below 17V the ERROR lamp is lit when 24V setting has been selected.
 - Alt 1.** Press START/STOP button to charge with 12V setting. To set the parameters for customized charging proceed with “CHARGING” step 6 to 9.
 - Alt 2.** Press INCREASE button to change to 24V setting. Press START/STOP button to resume. To set the parameters for customized charging proceed with “CHARGING” step 6 to 9.

CHARGING PROGRAMS

Choose program by pressing the MODE-button.
Adjust parameters according to "CHARGING" (6-9).
Press START/STOP button to start the selected program.

The table explains the different Charging Programs:

Program	Battery Size (Ah)	Explanation	Temp range
NORMAL	20-1200Ah 10-600Ah	Use for GEL, WET and MF batteries.	-20°C-+50°C (-4°F-+122°F)
AGM	20-1200Ah 10-600Ah	Use for most AGM batteries. Some AGM should use lower voltage (NORMAL Mode), check battery manual if unsure.	-20°C-+50°C (-4°F-+122°F)
Ca/Ca	20-1200Ah 10-600Ah	Use for Ca/Ca batteries. Use Ca/Ca program to maximize charge with minimum loss of fluid. Including RECOND step. Recond your battery once per year and after deep discharge to maximise lifetime and capacity.	-20°C-+50°C (-4°F-+122°F)
BOOST	20-1200Ah 10-600Ah	Used for recovery of stratified batteries.	-20°C-+50°C (-4°F-+122°F)
SUPPLY	20-1200Ah 10-600Ah	Use as power supply or use for float maintenance charging when 100% capacity of the battery is required. SUPPLY program activates step 7 without time or voltage limitation.	-20°C-+50°C (-4°F-+122°F)

12V			24V		
Current	Battery size Min	Battery size Max	Current	Battery size Min	Battery size Max
10A	20Ah	300Ah	5A	10Ah	150Ah
20A	40Ah	600Ah	10A	20Ah	300Ah
30A	60Ah	900Ah	15A	30Ah	450Ah
40A	80Ah	1200Ah	20A	40Ah	600Ah

- Using higher current than recommended may result in batteries not being completely charged.
- Using lower current than recommended will prolong the charging time.
- The currents are the maximum recommended current for battery charging. If a parallel consumer is connected then the current setting could be increased with this current value.
- Some battery manufacturer could recommend different values. Please check with the manufacturer if uncertain. The main recommendations are that Gel batteries should be charged in the lower current range, Power AGM's in the upper range and most other battery types in the mid-range.

 **WARNING!**
Risk of short circuiting the battery cables. Connect charger cables to the charger before connecting the battery 

 **WARNING!**
Risk of electrical shock if touching positive and negative terminals when charging 

TECHNICAL SPECIFICATION

Model number	1069
Rated Voltage AC	220-240VAC, 50-60Hz, 3.0A
Charging voltage	14.4V/14.7V/15.8V and 28.8V/29.4V/31.6V
Start voltage	2.0V
Output	Selectable, max 40A/12V or 20A/24V
Back current drain*	Less than 1Ah/month
Ripple**	Less than 4% of actual DC current
Ambient temperature	-20°C to +50°C (-4°F to +122°F)
Charger type	8 step fully automatic charging cycle
Battery types	All types of 12V and 24V lead-acid batteries (WET, MF, Ca/Ca, AGM and GEL). Check with your battery supplier for appropriate charge information
Battery capacity	12V: 20-1200Ah, 24V: 10-600Ah
Dimensions	254 x 160 x 76mm (L x W x H)
Insulation class	IP20
Weight	1.3kg without charge cable
Warranty	2 years

*) Back current drain is the current that drains the battery if the charger is not connected to the mains. CTEK chargers have a very low back current.

**) The quality of the charging voltage and charging current is very important. A high current ripple heats up the battery which has an aging effect on the positive electrode. High voltage ripple could harm other equipment that is connected to the battery. CTEK battery chargers produce very clean voltage and current with low ripple.

LIMITED WARRANTY

CTEK SWEDEN AB, issues this limited warranty to the original purchaser of this product. This limited warranty is not transferable. The warranty applies to manufacturing faults and material defects for 2 years from the date of purchase. The customer must return the product together with the receipt of purchase to the point of purchase. This warranty is void if the battery charger has been opened, handled carelessly or repaired by anyone other than CTEK SWEDEN AB or its authorised representatives. The charger is sealed. Removing or damaging the seal will void the warranty. CTEK SWEDEN AB makes no warranty other than this limited warranty and is not liable for any other costs other than those mentioned above, i.e. no consequential damages. Moreover, CTEK SWEDEN AB is not obligated to any other warranty other than this warranty.

CHARGING PROGRAMS

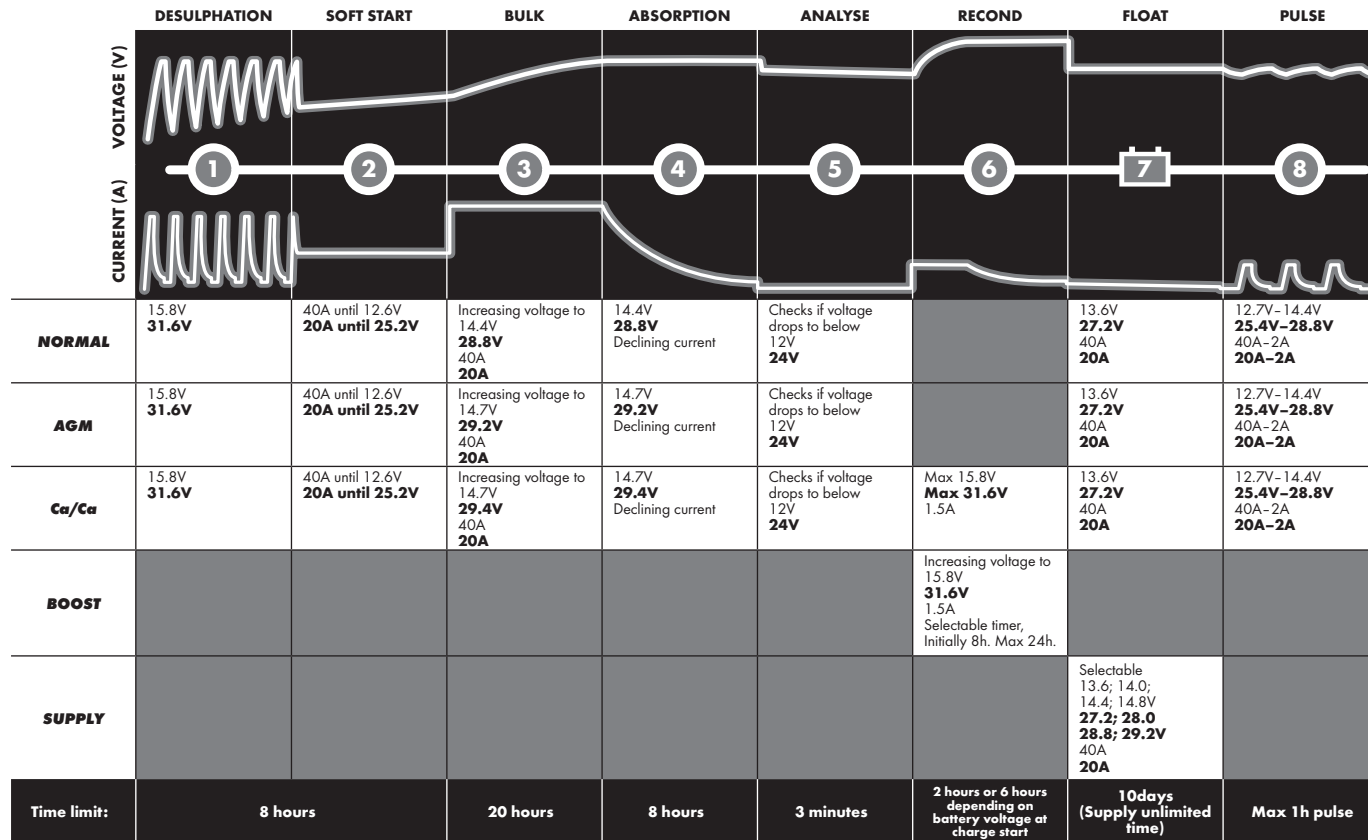

STEP 1 DESULPHATION

Detects sulphated batteries. Pulsing current and voltage, removes sulphates from the lead plates of the battery restoring the battery capacity.

STEP 2 SOFT START

Tests if the battery can accept charge. This step prevents charging a defective battery.

STEP 3 BULK

Charging with maximum current until approximately 80% battery capacity.

STEP 4 ABSORPTION

Charging with declining current to maximize up to 100% battery capacity.

STEP 5 ANALYSE

Tests if the battery can hold charge. Batteries that cannot hold charge may need to be replaced.

STEP 6 RECOND

Choose the Ca/Ca program to add the recondition step to the charging program. This step can also be selected separately by choosing the BOOST-program. During the recondition step voltage increases to create controlled gassing in the battery. Gassing mixes the battery acid and gives back energy to the battery.

STEP 7 FLOAT

This step maintains the battery voltage by providing a constant voltage charge. This step can also be selected separately by choosing the SUPPLY-program where it is possible to select different voltage settings. Follow battery manufacturers recommendation.

STEP 8 PULSE

Maintaining the battery at 95-100% capacity. The charger monitors the battery voltage and gives a pulse when necessary to keep the battery fully charged.

SUPPORT

CTEK offers professional customer support: www.ctek.com.

For latest user manual see www.ctek.com.

By e-mail: info@ctek.com, by telephone: +46(0) 225 351 80.

CTEK PRODUCTS ARE PROTECTED BY

2012-05-30

Patents	Designs	Trade marks
EP10156636.2 pending	RCD 509617	TMA 669987
US12/780968 pending	US D575225	CTM 844303
EP1618643	US D580853	CTM 372715
US7541778	US D581356	CTM 3151800
EP1744432	US D571179	TMA 823341
EP1483817 pending	RCD 321216	CTM 1025831
SE524203	RCD 000911839	CTM 405811
US7005832B2	RCD 081418	CTM 830545751 pending
EP1716626 pending	RCD 001119911-0001	CTM 1935061 pending
SE526631	RCD 001119911-0002	V28573IP00
US7638974B2	RCD 081244	CTM 2010004118 pending
EP09180286.8 pending	RCD 321198	CTM 4-2010-500516
US12/646405 pending	RCD 321197	CTM 410713
EP1483818	ZL 200830120184.0	CTM 2010/05152 pending
SE1483818	ZL 200830120183.6	CTM1042686
US7629774B2	RCD 001505138-0001	CTM 766840 pending
EP09170640.8 pending	RCD 000835541-0001	
US12/564360 pending	RCD 000835541-0002	
SE528232	D596126	
SE525604	D596125	
	RCD 001705138-0001	
	US D29/378528 pending	
	ZL 201030618223.7	
	US RE42303	
	US RE42230	

EN

20019374D